

# 千葉県型側・ふた

CH1 (歩道用)

側溝(CH1)

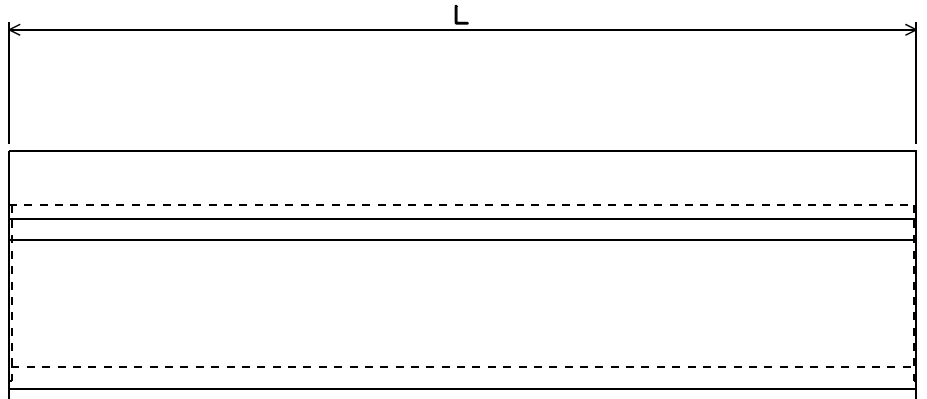
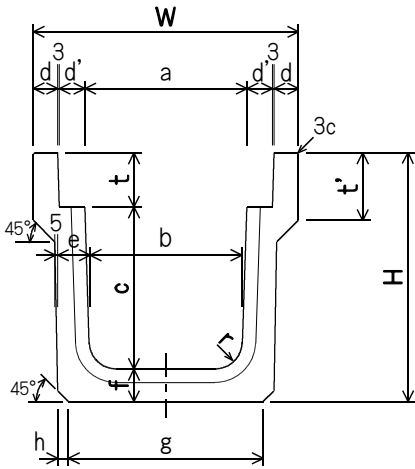

単位:mm

呼び	寸法														参考重量 (kg)	
	a	b	c	d	d'	e	f	g	h	t	t'	r	W	H		L
CH1-30-30	300	280	300	45	47	60	60	360	20	100	125	50	490	460	200	342
CH1-30-40	300	270	400	45	47	65	65	360	20	100	125	50	490	565	200	414
CH1-30-50	300	260	500	45	47	70	70	360	20	100	125	50	490	670	200	491
CH1-30-60	300	250	600	45	47	75	75	360	20	100	125	50	490	775	200	572
CH1-40-40	400	370	400	45	47	65	65	460	20	100	125	50	590	565	200	445
CH1-40-50	400	360	500	45	47	70	70	460	20	100	125	50	590	670	200	524
CH1-40-60	400	350	600	45	47	75	75	460	20	100	125	50	590	775	200	608

ふた

CHL1-30

(37kg)

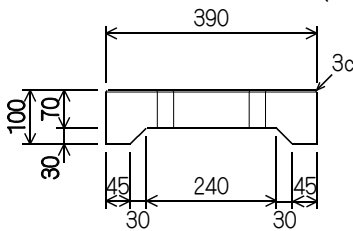

CHL1-40

(46kg)

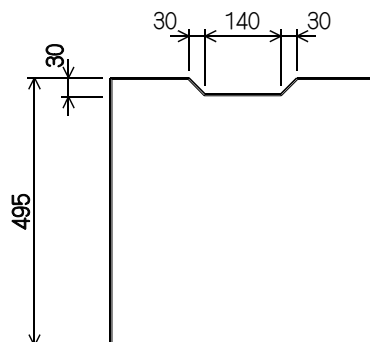
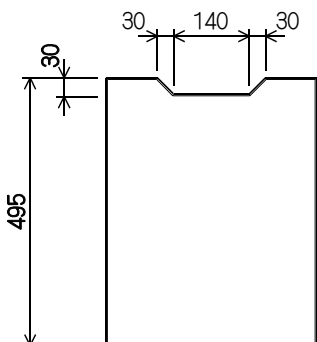
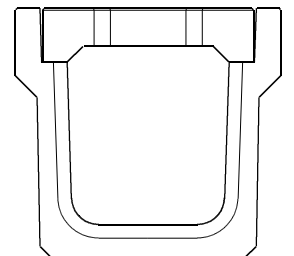
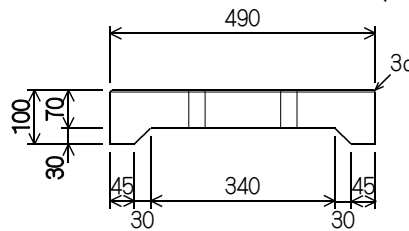

# 千葉県型側溝・ふた

CH25(縦断T-25)

## 側溝(CH25)

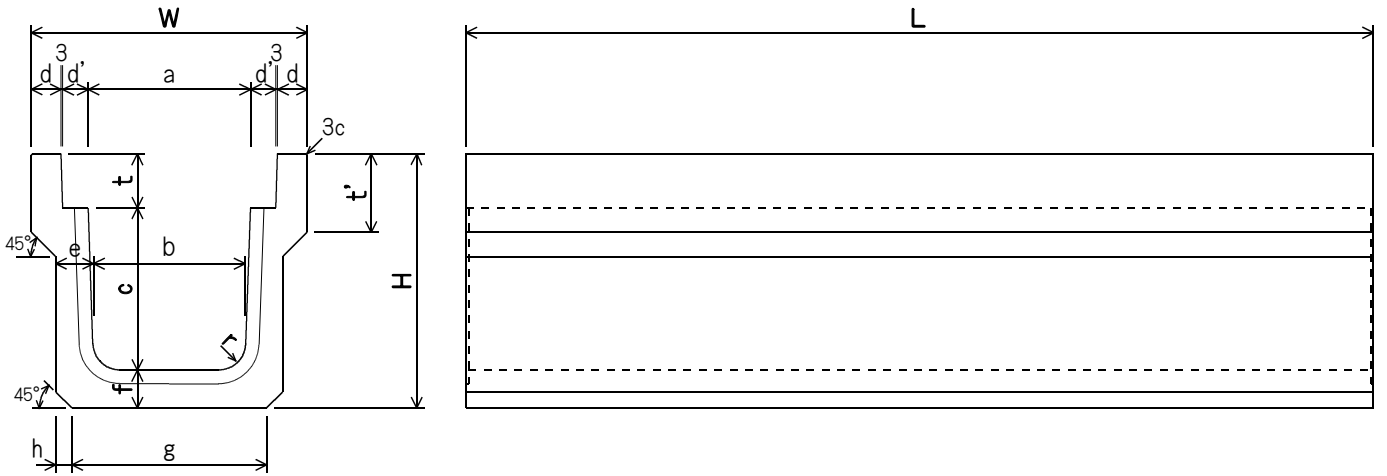

単位:mm

呼び	寸法															参考重量 (kg)
	a	b	c	d	d'	e	f	g	h	t	t'	r	W	H	L	
CH25-30-30	300	280	300	55	47	70	70	360	30	100	145	50	510	470	2000	413
CH25-30-40	300	270	400	55	47	75	75	340	40	100	145	50	510	575	2000	491
CH25-30-50	300	260	500	55	47	80	80	340	40	100	145	50	510	680	2000	578
CH25-30-60	300	250	600	55	47	85	85	340	40	100	145	50	510	785	2000	670
CH25-40-40	400	370	400	60	47	70	70	430	40	100	140	50	620	570	2000	504
CH25-40-50	400	360	500	60	47	80	80	440	40	100	140	50	620	680	2000	623
CH25-40-60	400	350	600	60	47	85	85	440	40	100	140	50	620	785	2000	717

## ふた

CHL25-30

(46kg)

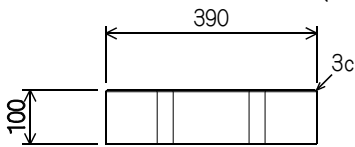

CHL25-40

(67kg)

