

BFSLブロック

施工図

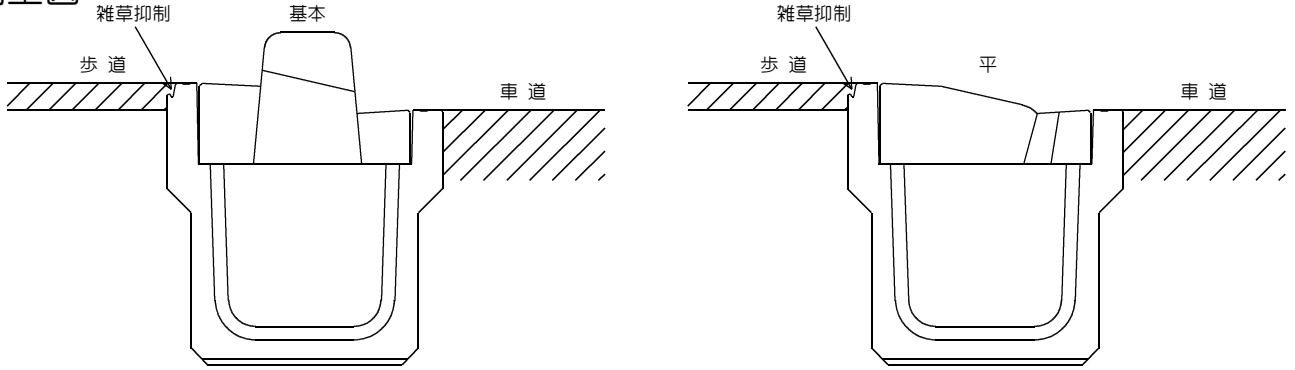

BFSLタイプ°

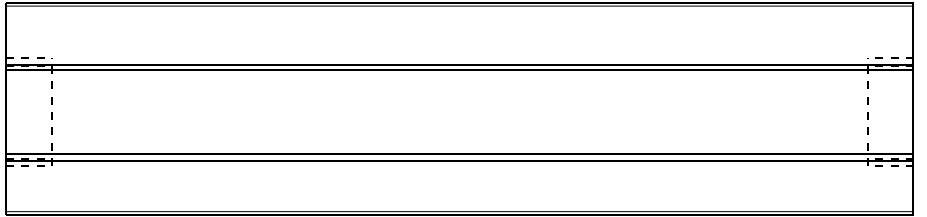
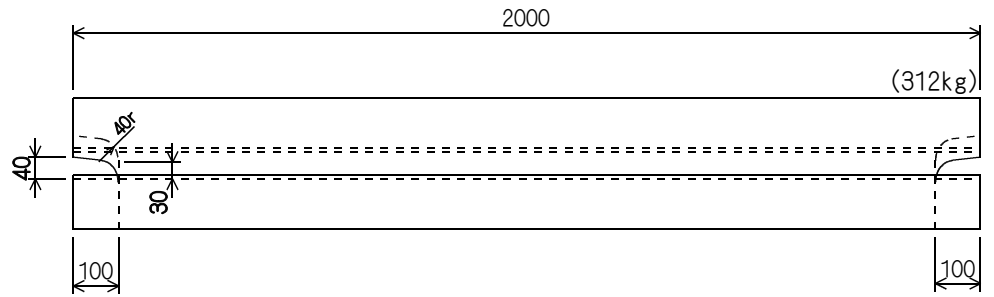
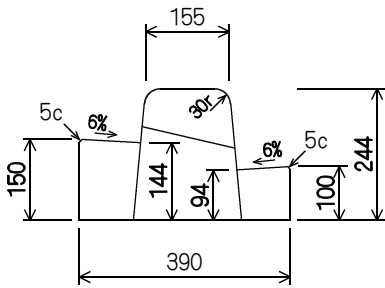

BFSLDタイプ°

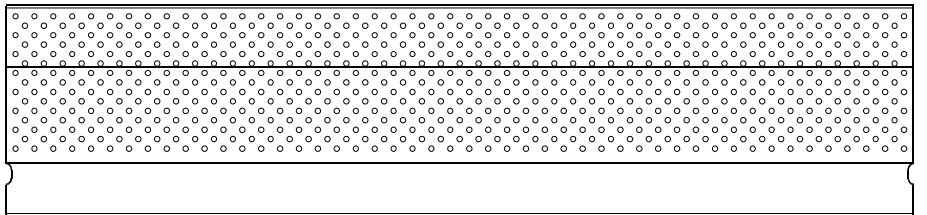
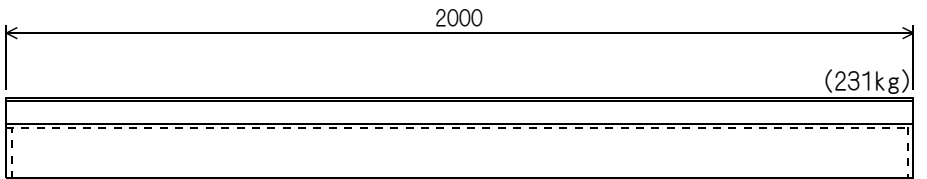
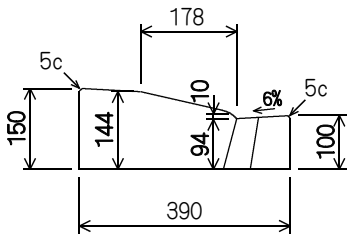

水抜き穴詳細図

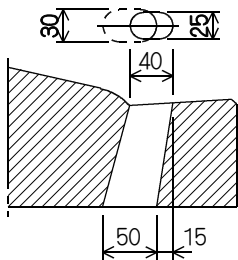

BFSLブロック

BFSLTタイプ°(左)

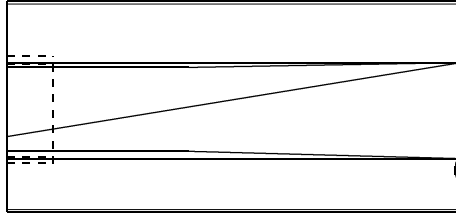
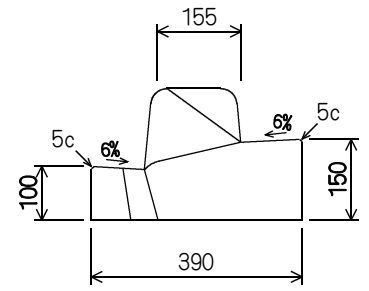
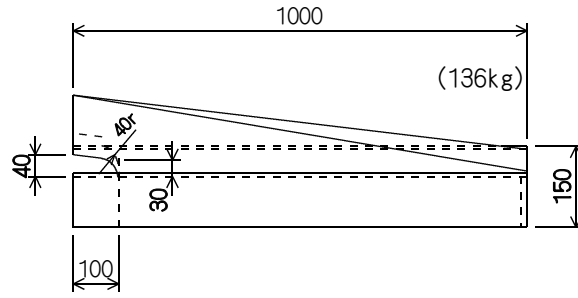
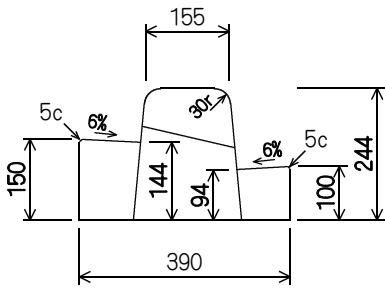

BFSLTタイプ°(右)

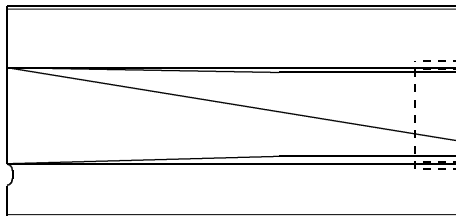
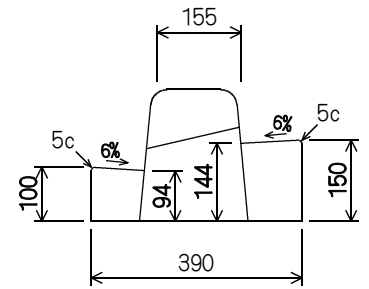
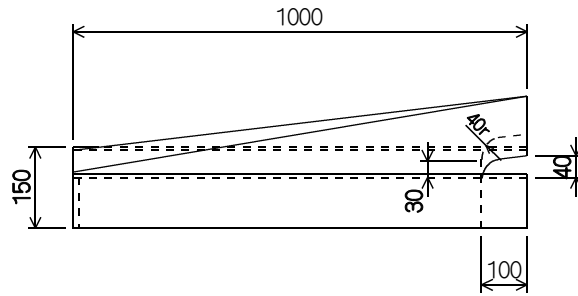
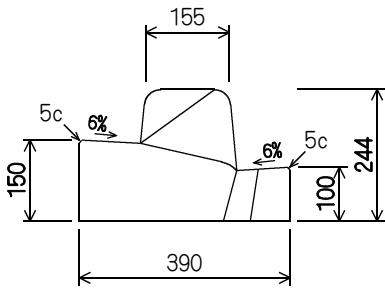

BFSLタイプ°(縁塊)

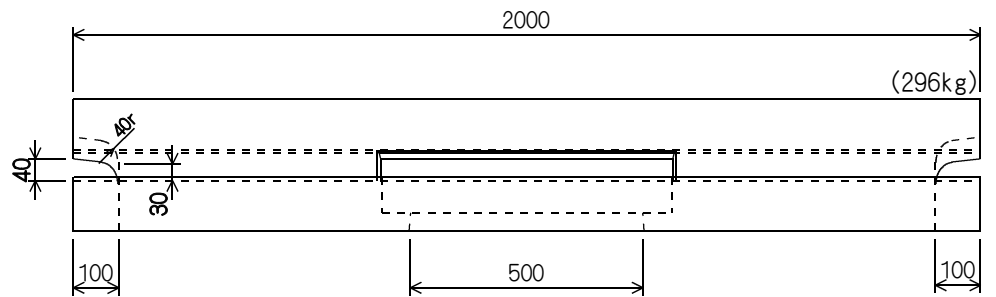
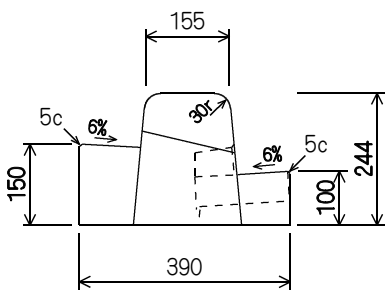

グレーチング

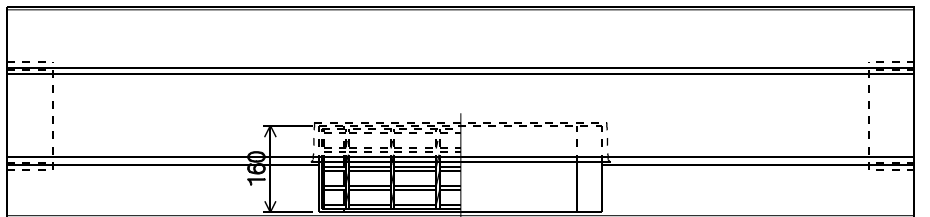
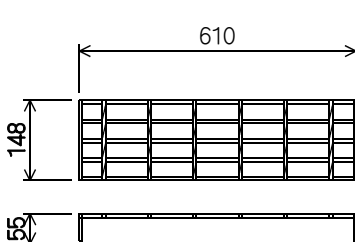

BFSL 柵

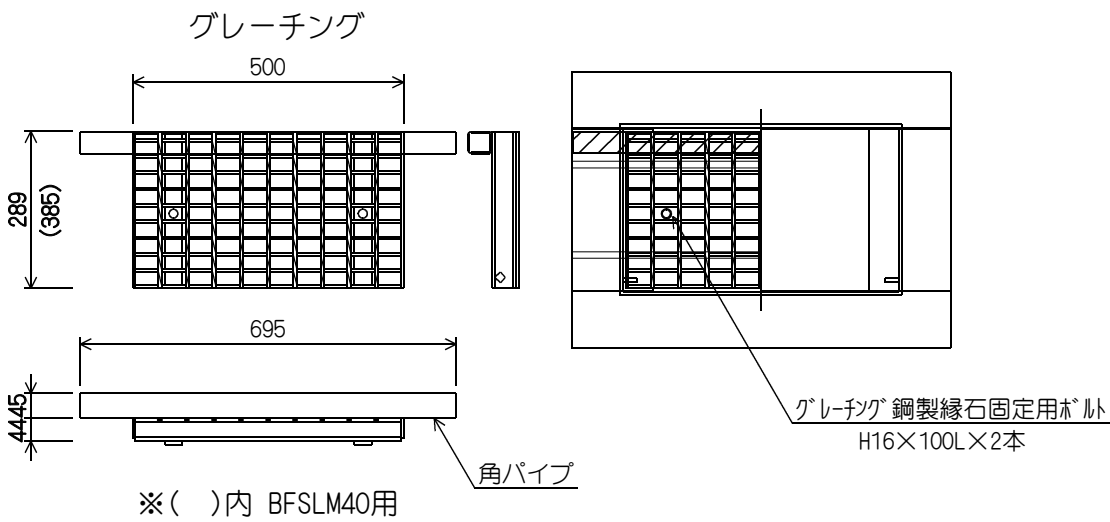
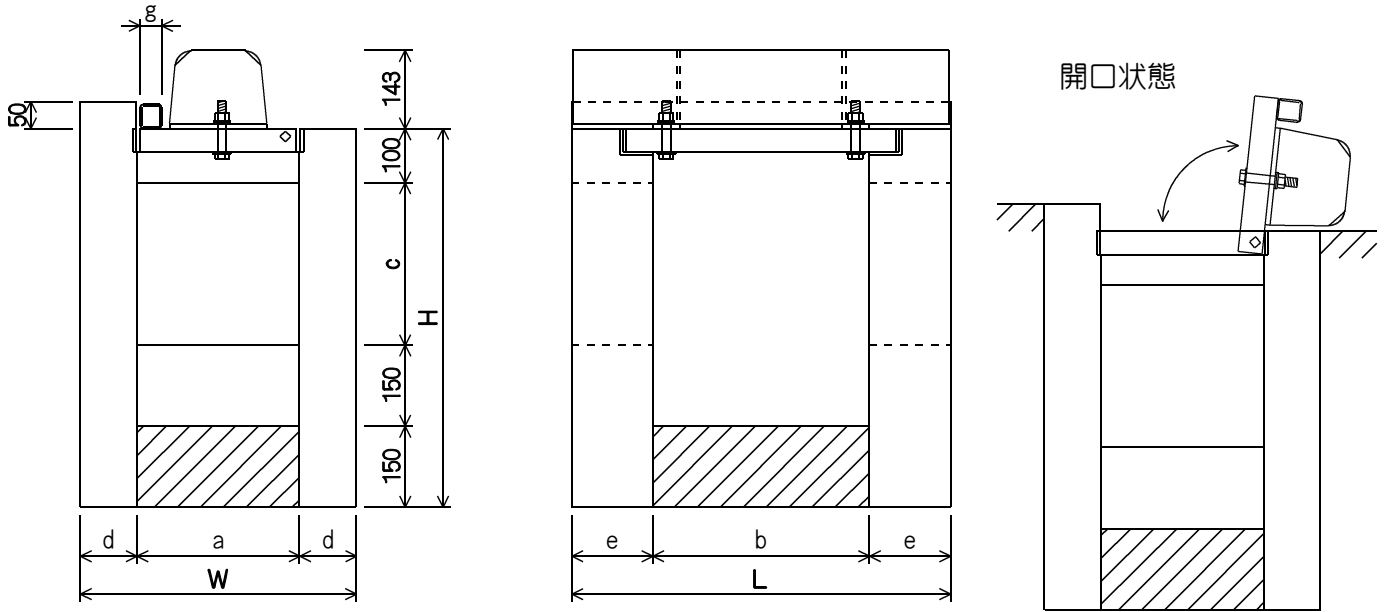

単位: mm

呼び	寸法									参考重量 (kg)
	a	b	c	d	e	g	W	H	L	
BFSLM30-30	300	400	300	105	150	40	510	700	700	448
BFSLM30-40	300	400	400	105	150	40	510	800	700	505
BFSLM30-50	300	400	500	105	150	40	510	900	700	562
BFSLM30-60	300	400	600	105	150	40	510	1000	700	619
BFSLM40-40	400	400	400	110	150	90	620	800	700	593
BFSLM40-50	400	400	500	110	150	90	620	900	700	658
BFSLM40-60	400	400	600	110	150	90	620	1000	700	724

*H寸法は現場の状況に応じて変更出来ます。